

GALILEO

TILT & SLIDE SYSTEM



Open, Close, Live

GALILEO the hardware system for

Our large, glass doors let you bring the scenery inside using space efficiently while eliminating leaks and drafts.

GALILEO is the new hardware system for tilt & slide sashes that allows for ample natural light and easy outdoor access.

The GALILEO system ensure reliability, convenience and longevity.





The solution to many problems



Noise, wind and rain are sealed out

GALILEO provides greater comfort and helps you save energy. Thanks to the multiple adjustable locking points, distributed around the entire perimeter, the sash applies uniform pressure on the seals and noise proofing is considerably improved. Moreover, drafts and water infiltration during rainstorms are eliminated.



Space is no longer a problem

The GALILEO movable sash is reduced in bulk to a minimum even when fully open, thus saving precious space in small rooms. Curtains can be drawn even when the sash is open.



Ventilation, but safely

When tilted open, the sash allows a continuous and controlled inflow of air without the intrusion of noise and weather.



One system, many solutions

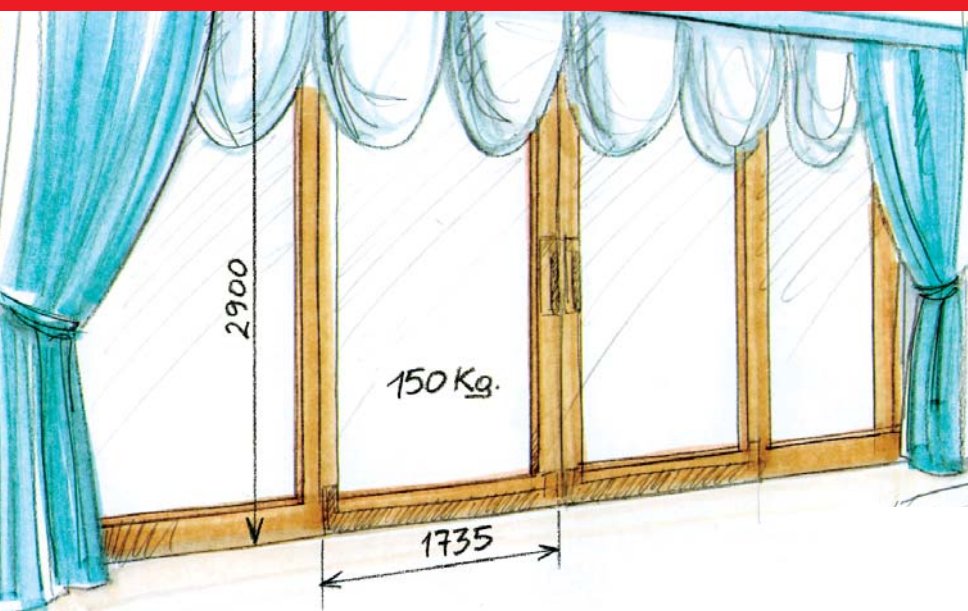

GALILEO can be installed on any door or window made of wood, PVC or aluminium/wood that has the standard 16 millimetre European groove.

No special framework is required.

You can have doors and windows with sashes up to 1,735 mm in width and 2,900 mm in height. Weight is not a problem: GALILEO is guaranteed up to 150 kg.

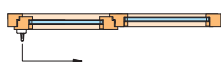
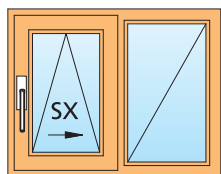

Diagram A

One sliding sash and one fixed sash.

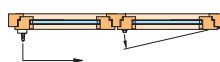
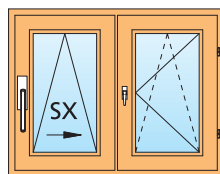

Diagram B

One sliding sash and one swing sash with mullion.

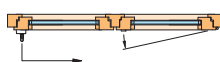
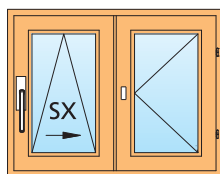

Diagram B1

One sliding sash and one swing sash without mullion; system central point with mullion to be installed (MR central point).

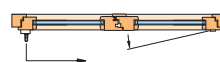
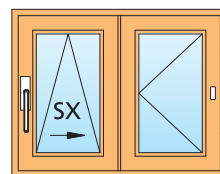

Diagram B2

One sliding sash and one swing sash without mullion; system central point with inversion of standard rebate (SB central point); hinge side handle.

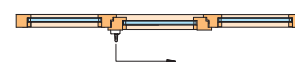
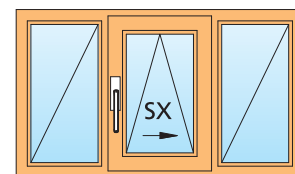

Diagram C

One center sliding sash and two fixed side sashes.

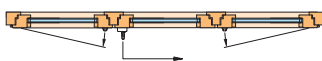
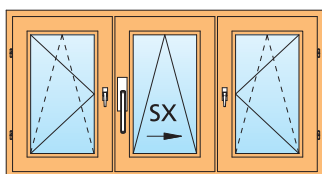

Diagram C1

One center sliding sash and two side swing sashes with mullion.

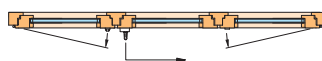
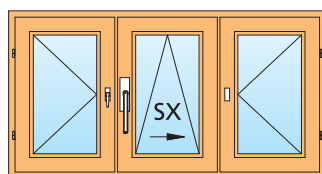

Diagram C2

One center sliding sash and two side swing sashes without mullions; system central point with mullions to be installed (MR central point).

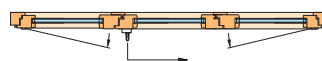
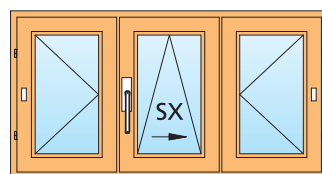

Diagram C3

One center sliding sash and two side swing sashes without mullions; system central point with inversion of standard rebate (SB central point); hinge side handle.

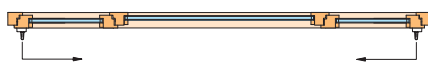
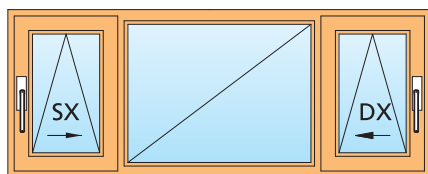

Diagram D

Two inward sliding side sashes and one fixed center sash having the same width as the two sliding sashes combined.

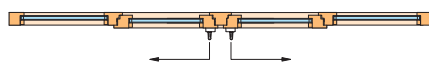
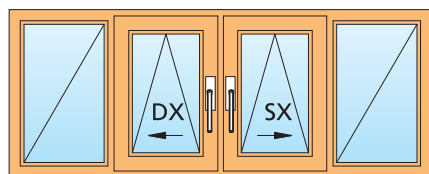

Diagram E

Two outward sliding coaxial center sashes and two fixed side sashes. System central point, between the two sliding sashes, with mullion to be installed (MR central point) and single control handle on both sliding sashes.

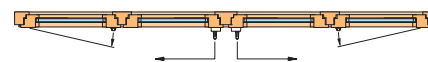
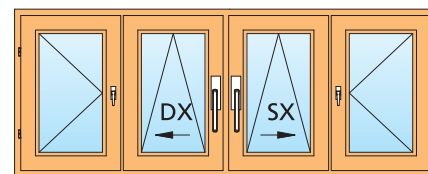

Diagram F

Two outward sliding coaxial center sashes and two swinging side sashes. System central point, between the two sliding sashes, with mullion to be installed (MR central point) and single control handle on both sliding sashes.

Versatile, easy to order and manage

GALILEO is a modular system, available in left- or right-hand versions, allowing for a wide range of solutions and measurements with a minimum number of elements.

The main components of the system are separated into groups according to their functions, and each is contained in a practical basic kit.

Selecting, ordering and managing are thus made easier and more economical.

The selection criteria, e.g. type, side, colour and dimensions of the sliding sash, are clearly indicated in the price list.

The basic kit comes with the assembly manual, the operating and maintenance instructions to be delivered to the user, and a sticker to be applied to the glass, describing the handle functions.

To facilitate assembly, all the drive elements are locked in the closed position.



CLOSED POSITION

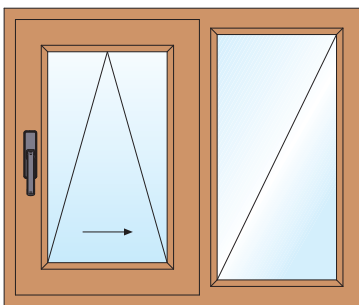

(fig. 1)

TILT-OPEN POSITION

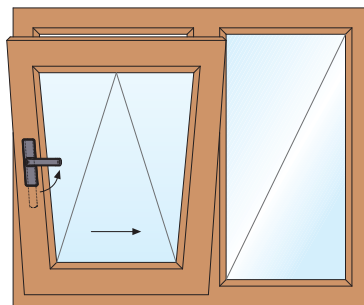

(fig. 2)

SLIDING POSITION

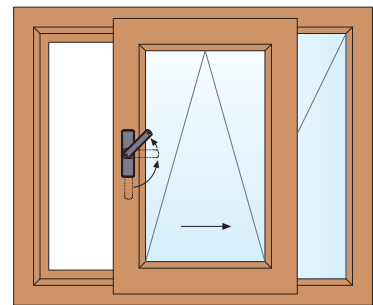

(fig. 3)

AUTOMATIC GALILEO

All functions are activated automatically by the operating handle: closing (fig. 1), tilt position (fig. 2) sliding position (fig. 3)

SEMI-AUTOMATIC GALILEO

In order to reach the closing position (fig. 1), the DK handle must be rotated downwards up to the vertical position only after pushing the sash in closing position. The automatic hooking of the lower corner drives allow to automatically position the sash on tilt (fig. 2). To reach the sliding position (fig. 3) the handle must be rotated upwards up to the vertical position first in order to allow the un-hooking of the corner drives and then be rotated up to the horizontal position to drag the sash.

MANUAL COMMAND GALILEO

In order to reach the closing position (fig. 1), the DK handle must be rotated downwards up to the vertical position only after pushing the sash in closing position. The tilt position (fig. 2) is reached by pushing the sash towards the frame and then rotating the handle upwards up to the vertical position. To reach the sliding position (fig. 3) the handle must be rotated until horizontal position in order to un-hook the corner drives and to drag the sash.

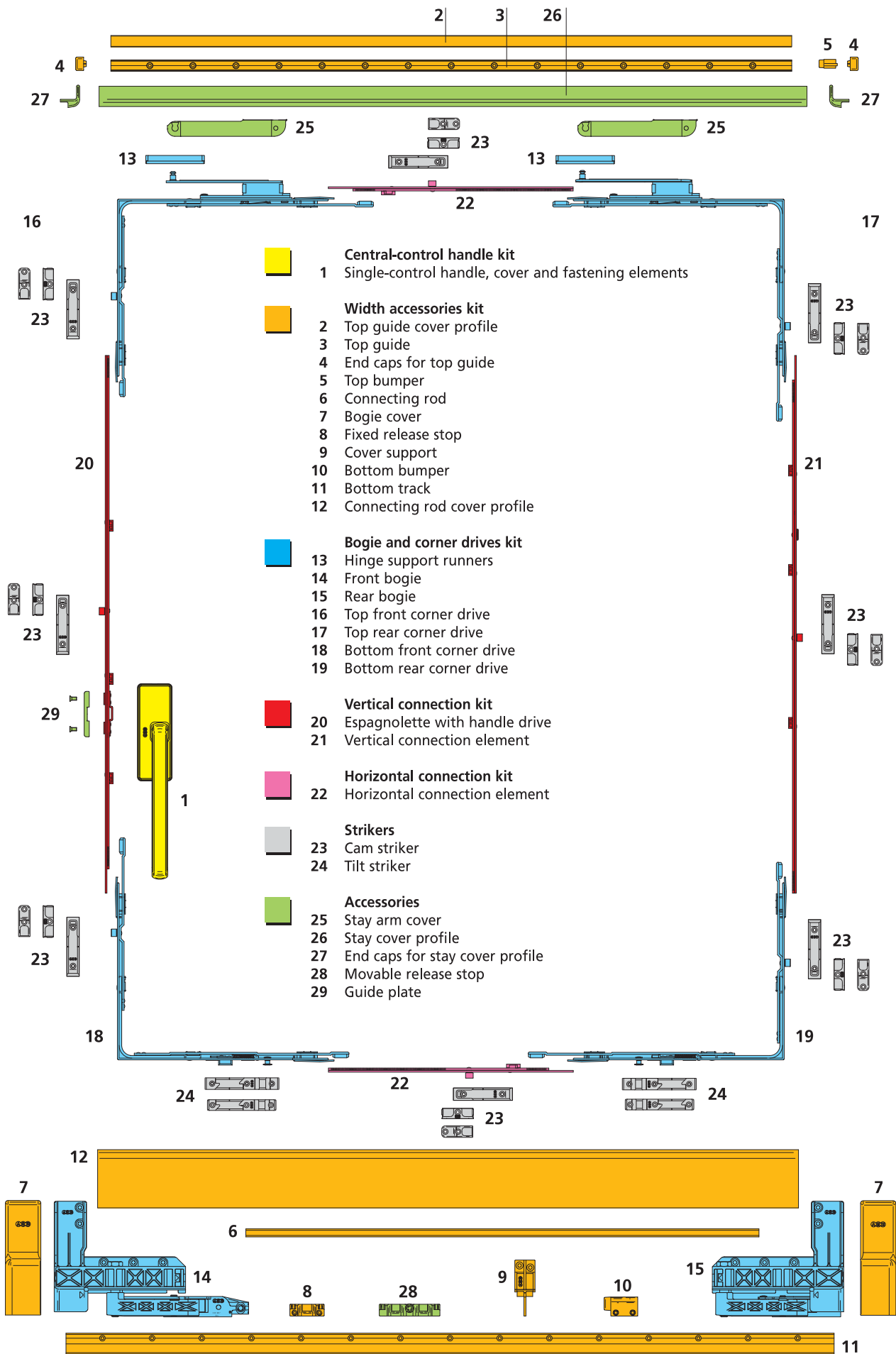

Multi-functional handle and horizontal and vertical connectors kits

One handle, many advantages

GALILEO's multi-functional handle accounts for smooth, one-handed operation in all three positions:

- 1) Locking
- 2) Tilting
- 3) Sliding

A snap mechanism ensures proper locking of the selected position. In position (2) the sash, having reached the end of travel, automatically hooks onto the frame. In position (3) the "automatic locking" option is deactivated.

Automatic locking, but only when required!



Vertical and horizontal link ENSAT M5 bushings that prevent against stripping are also used. The handle kit includes all the screws and accessories for assembly.



If the section of the sash is sufficiently wide, the handle is inserted directly in the espagnolette, inside the hardware groove. For narrow sections, a suitable blade guiding plate, supplied as an accessory, allows you to position the blade on the outside of the groove.

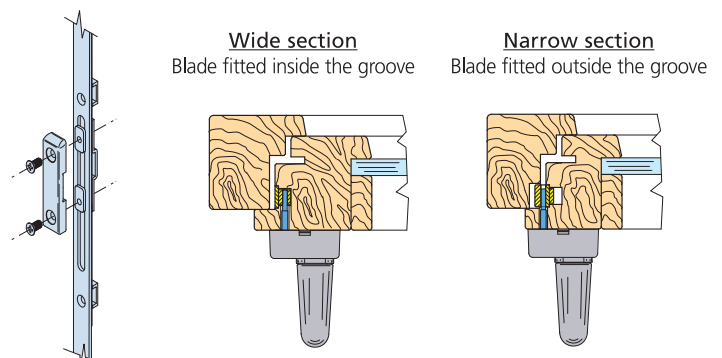

The GALILEO handle is made of aluminium and is available in the following versions: left- or right-hand, white RAL 9010, aluminium silver, brass anodized, brown.



All Galileo rods are trimmable, to match the size of the sash.



Sliding bogies



Carriages are supplied pre-assembled and lubricated, ready for installation.

Reference guide for cutting the link rod.



Link rod with shaped cross-section for carriage synchronization.

Carriage height adjustment lock nut.

Stainless steel rod fastening dowels.

Limit device on both carriages to distribute the end-of-travel impact.

Wheels made of special self-lubricating plastic, protected by dust-proof runners. They do not wear out or distort with time. Mounted on screened ball bearings.

Link pin on axial ball bearings.

Reference markings for cutting the lower cover trim to size.

Stop dowel with rotating steel sleeve.



Wide vertical adjustment, -3 to +6 mm.

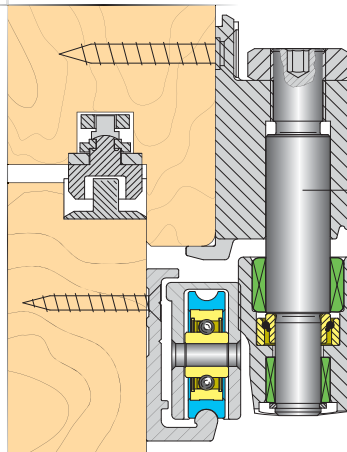

Main pivot made of durable, hardened and ground steel, mounted on two radial roller bearings and one axial ball bearing.

Corner drives

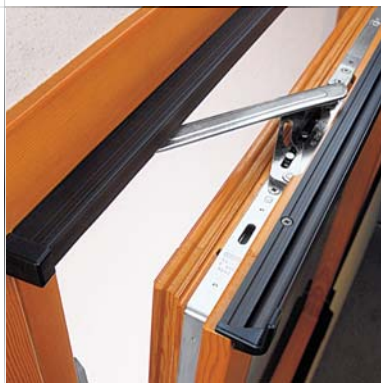
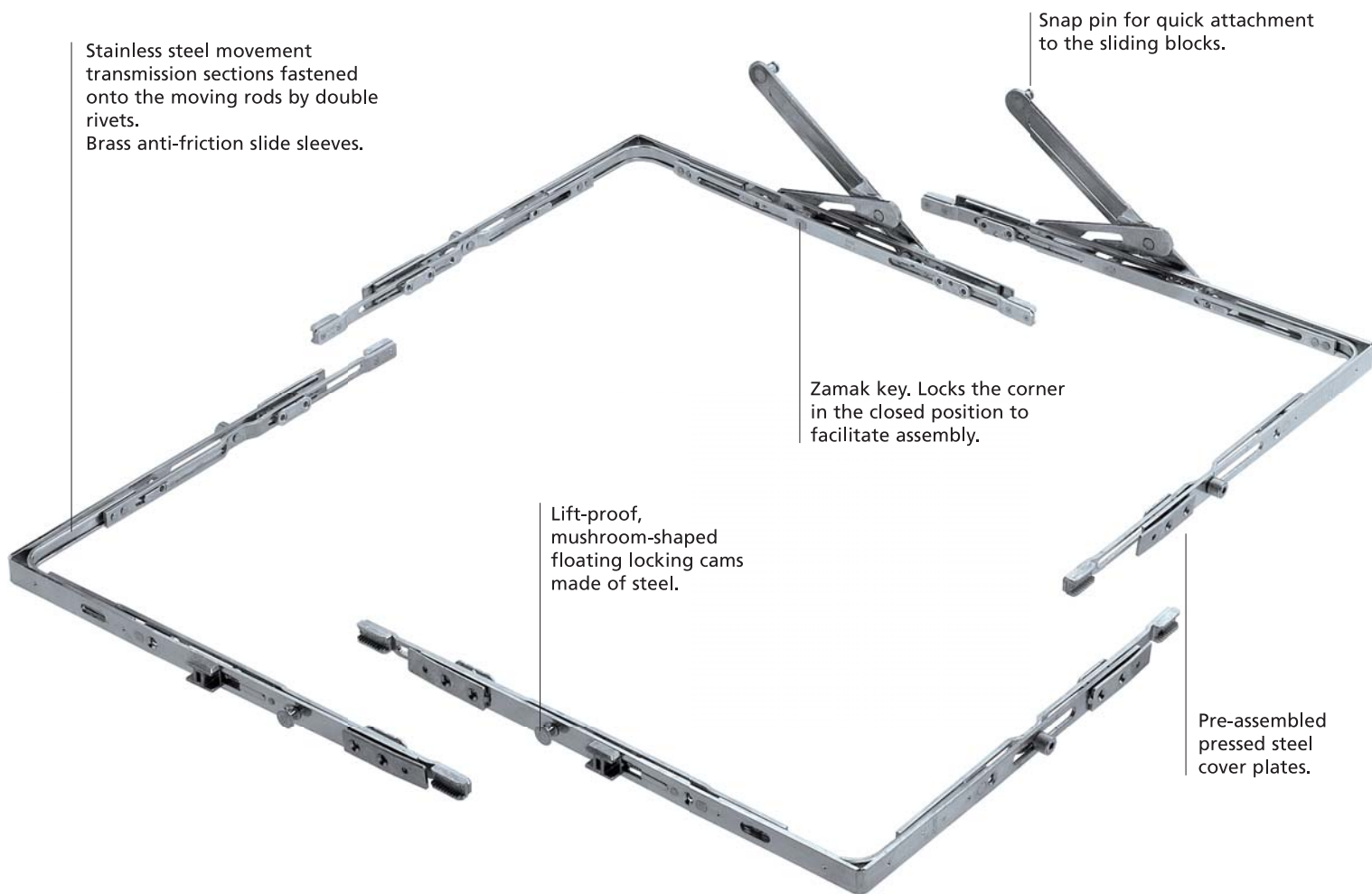

Compact upper hinge assemblies for a wide range of solutions in the manufacture and adjustment of the door/window.

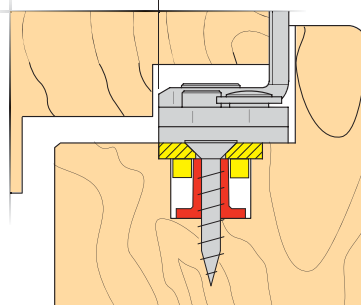

The hinge fits completely inside the milling (18x8 - gap 12 mm).

A shim for every fastening hole keeps the slide rod in the proper position. This allows for maximum tightening of the screws without hindering the smooth operation of the system.



The lower corner drives are fitted with a lift-proof locking cam. Corner drives with theft-proof push rod can be installed on the semi-fixed sash.



Cylindrical locking cams with eccentric adjustment allow for uniform pressure to be applied to the seals. The locking cams are made of cold-pressed steel with brass anti-friction rotating sleeve. Adjusted by means of a 4 mm hex wrench.

Slide guides



Extruded aluminium upper guide (1) for the sliding of the sash by means of two sliding blocks (2) that house the upper hinge pins.

The sash limit bumper is inserted into the upper guide.

The plastic trim (3) conceals the upper guide fastening holes.

Optional plastic (4), or aluminium trim (5), may be installed for a streamline appearance.



On the bottom side, an anodized aluminium rail (6) supports and guides the sliding of the two carriages.

The carriages are linked by a shaped cross-section rod (7).

The lower limit bumper (10) and the fixed or mobile release block (optional) (11) are mounted onto the rail. The slide components are protected by an anodized aluminium trim (8) and two side conceals (9).

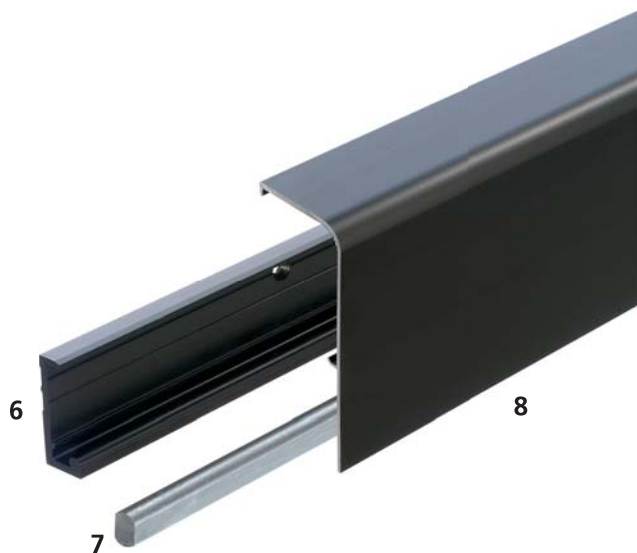
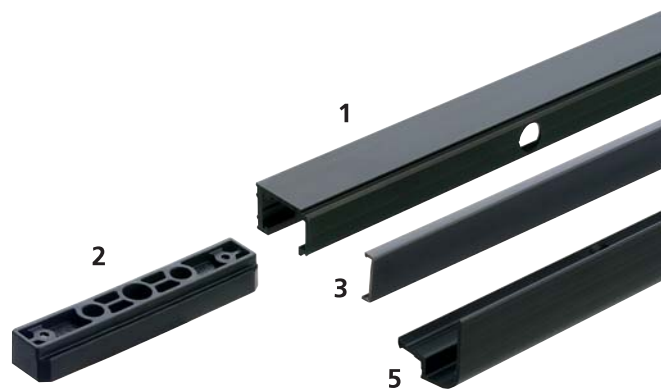

9



GALILEO SA

Semi-Automatic

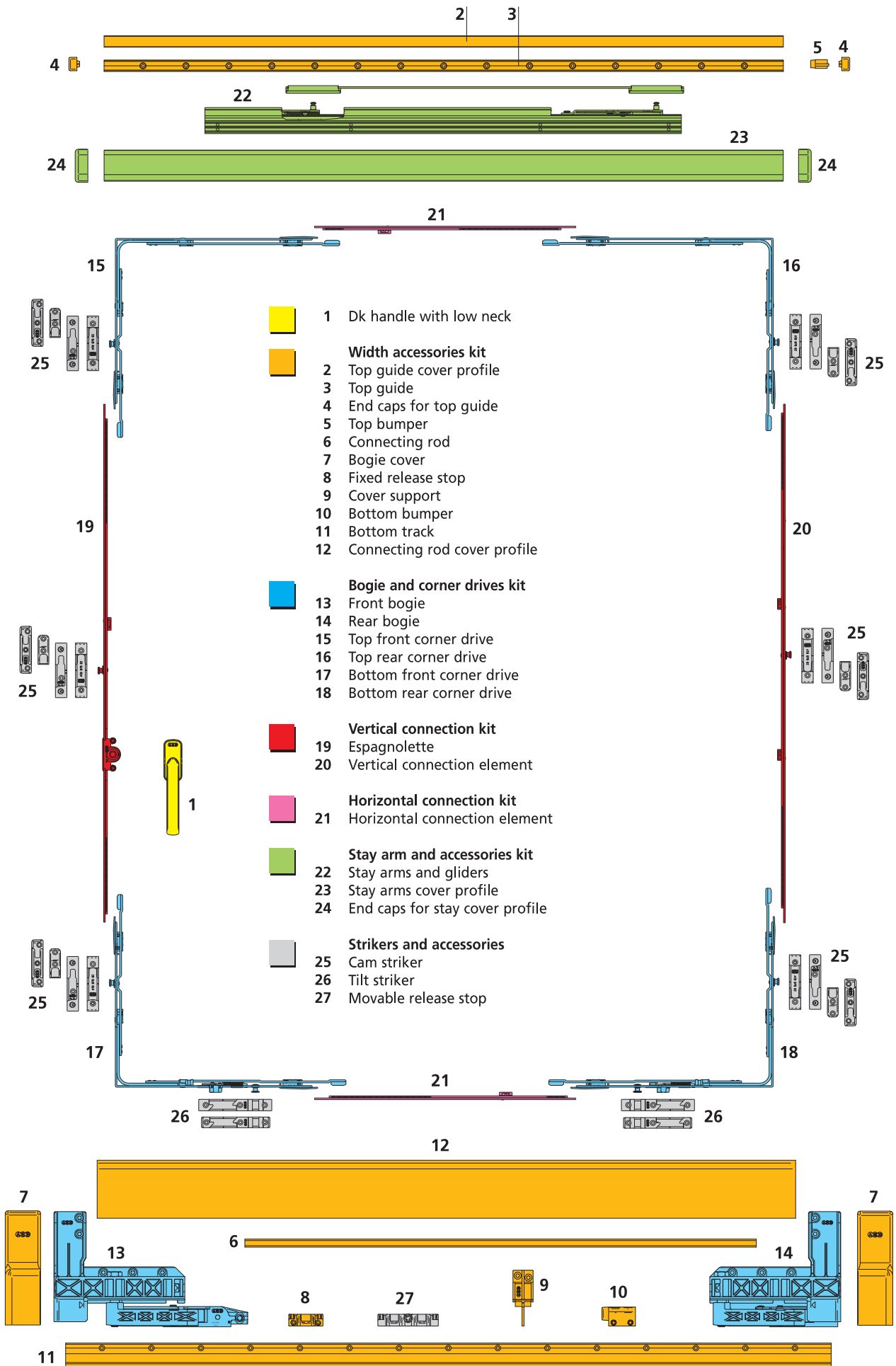

GALILEO CM Manual Command

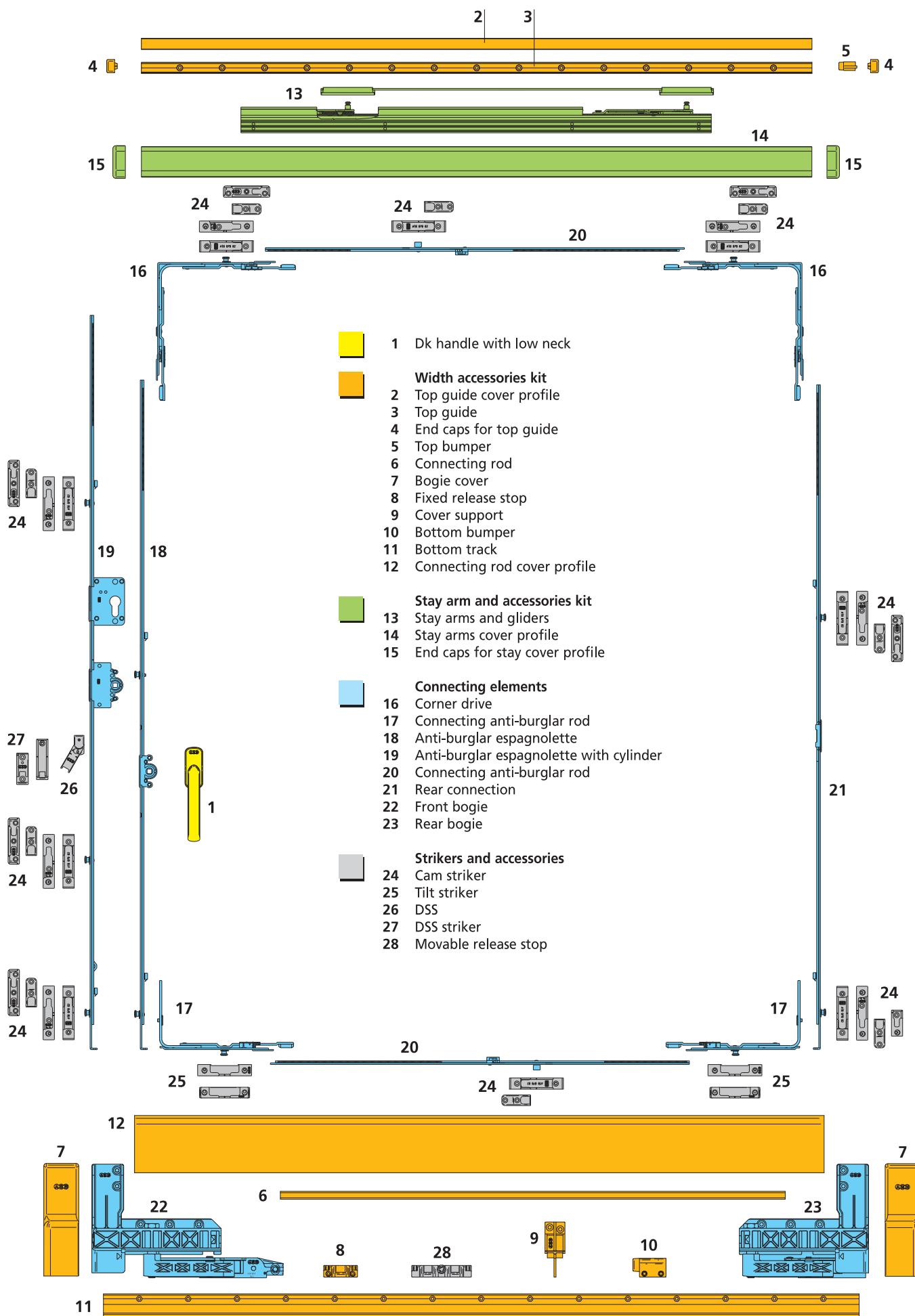

GALILEO Semi-Automatic and Manual Command

Galileo Semi-Automatic and Manual Command

Are the new coplanar sliding systems which keep the main functions of Galileo Automatic and allow the same working of the normal swinging window. More in detail, Galileo SA, keeps the automatic hooking of the lower bogies thanks to the proper corner drives, while Galileo CM must be manually commanded with the handle to allow the locking cams to reach the tilt position.



The use of a DK handle for tilt sashes, gives aesthetical affinity with the other windows of the house and allow to use rounded profiles as well.

Espagnolettes, rods, and corner drives are supplied with telescopic mushroom cams for a higher burglar-proof.



The accessories are not connected to the axis of the window thanks to the stay arms mounted on the applied profile on the top transom.

The perimetral components of the Galileo CM are the same of tilt & turn ones. This means an important reduction of the hardware warehouse.



GALILEO features a wide variety of accessories and finishing elements for semi-fixed sashes and special solutions. Two solutions are available for the swing sashes in diagrams B, C1 and F, fitted with TOP series AGB espagnolettes:

1 - a DK handle with lowered neck and fitted with a support, to be installed on the sash.

2 - the DK handle and the plastic support, separately. Only the support and its cover are installed on the sash. The cover must be lifted when you need to use the handle to open the sash.



Movable release block allows the sliding sash to be moved forward to open the swing sash in diagrams B1, B2, C2, C3 and F.



GALILEO is equipped with a complete set of jigs and corresponding rods which allow you to perform the preparation and assembly operations more quickly and accurately. Whenever possible, the jigs are multi-functional, i.e. one jig allows you to perform multiple operations.

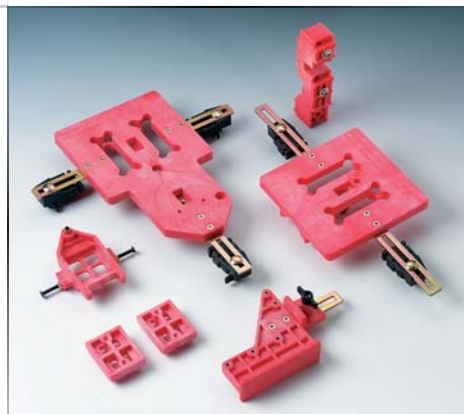

AGB Service

The GALILEO tilt & slide system is supplemented by very comprehensive assembly instructions and a strong support group of AGB technicians, always ready to offer their suggestions to any potential problem. More good reasons to choose AGB.



Open, Close, Live

Alban Giacomo SpA
Via A. De Gasperi 75
36060 Romano d'Ezzelino (VI) Italy
Tel. +39 0424 832 832
www.agb.it - info@agb.it